

# PRODUCT CERTIFICATE

## NAME OF PRODUCT

Kerto-S and Kerto-Q  
Structural laminated veneer  
lumber

## MANUFACTURER

Metsäliitto Cooperative  
Metsä Wood  
P.O. Box 24  
FI-08101 LOHJA  
Finland



## PRODUCT DESCRIPTION

The Kerto-S and Kerto-Q products are laminated veneer lumber products for use as structural or non-structural elements in buildings and bridges. The thickness range of Kerto-S is 21 - 90 mm and that one of Kerto-Q is 21 - 75 mm. The other dimensions are available in great ranges. The products are manufactured from spruce (*Picea abies*) or pine (*Pinus sylvestris*) veneers with a nominal thickness of 3 mm, using an adhesive suitable for exterior conditions. In Kerto-S, all veneers are parallel grained. In Kerto-Q, some of the veneers are cross grained.

The Kerto products are CE-marked according to EN 14374.

This certificate gives the necessary design information and guidelines related to the use of the products.

## CERTIFICATION PROCEDURE

This certificate has been issued by Eurofins Expert Services Oy, which is a certification body (S017) accredited by FINAS.

This certificate is based on an initial type assessment of the product, and an initial inspection of the factory and the factory production control according to the certification criteria R025. The general certification procedures are based on the certification system of Eurofins Expert Services Oy.

This certificate is valid until August 27, 2025. The conditions of validity are described in section 16.

## REGULATIONS, STANDARDS AND INSTRUCTIONS

### 1. European product requirement standards

**1.1** The Kerto-S and Kerto-Q products are CE-marked according to EN 14374 Timber structures – Structural laminated veneer lumber – Requirements.

**1.2** This certificate gives the necessary design information according to the Eurocodes. Since the regulations are not harmonised, the user is recommended to consider separately the relevant national regulations regarding the intended use.

### 2. Other standards and instructions

**2.1** The following European standards also have relevance for the use of Kerto products (any national determined parameters shall separately be considered):

EN 335	Durability of wood and wood-based products - Use classes: Definitions, application to solid wood and wood-based products
EN350	Durability of wood and wood-based products. Testing and classification of the durability to biological agents of wood and wood-based materials
EN 1995-1-1+A1+A2	Eurocode 5: Design of timber structures - Part 1-1: General - Common rules and rules for buildings
EN 1995-1-2	Eurocode 5: Design of timber structures - Part 1-2: General - Structural fire design
EN 1995-2	Eurocode 5: Design of timber structures - Part 2: Bridges
EN ISO 10456	Building materials and products. Hygrothermal properties - Tabulated design values and procedures for determining declared and design thermal values

## PRODUCT INFORMATION

### 3. Product description, marking and quality control

**3.1** Kerto-S and Kerto-Q products are manufactured by Metsäliitto Cooperative, Metsä Wood at the mills located in Lohja and Punkaharju.

**3.2** Kerto products are manufactured from veneers peeled from spruce (*Picea abies*) or pine (*Pinus sylvestris*), which have the nominal thickness of 3 mm after pressing. All veneers are graded with regard to strength and appearance in order to have the desired quality of the product. The minimum number of veneers is 7.

**3.3** The lay-up of the cross-section of Kerto-S consists of parallel grained veneers.

**3.4** The lay-up of the cross-section of Kerto-Q has some cross grained veneers. The lay-ups are given in Table 1.

*Table 1. Lay-up of Kerto-Q-products.*

Nominal thickness mm	Number of plies	Lay-up
21	7	—   —
21	7	— —
24	8	— —
27	9	—   —
30	10	—   —
33	11	—   —
39	13	—   —  —
45	15	—   —  —  —
51	17	—   —  —  —  —
57	19	—   —  —  —  —  —
63	21	—   —  —  —  —  —  —
69	23	—   —  —  —  —  —  —  —
75	25	—   —  —  —  —  —  —  —  —

**3.5** The veneers are glued together using an adhesive suitable for exterior use. On one side of a veneer, phenol-formaldehyde glue is spread evenly. The veneers are scarf jointed using a phenol-formaldehyde adhesive. However, the surface veneers on one side of the product are scarf jointed using melamine or melamine urea-formaldehyde adhesive. Some inner veneers are butt jointed.

**3.6** The products are cut and sawn according to the specification of the customer. The standard sizes of the products are given in Table 2.

Kerto beams and panels are delivered in customer lengths or market area specific standard lengths. The maximum length is 25 m.

*Table 2. Standard sizes of Kerto products.*

Product <sup>1</sup>	Thickness mm	Width / height (mm)								
		200	225	260	300	360	400	450	500	600
S/Q	27	x	x							
S/Q	33	x	x	x						
S/Q	39	x	x	x	x					
S/Q	45	x	x	x	x	x				
S/Q	51	x	x	x	x	x	x			
S/Q	57	x	x	x	x	x	x	x		
S/Q	63	x	x	x	x	x	x	x	x	
S/Q	69	x	x	x	x	x	x	x	x	x
S/Q	75	x	x	x	x	x	x	x	x	x
S	81	x	x	x	x	x	x	x	x	x
S	90	x	x	x	x	x	x	x	x	x

<sup>1</sup> Kerto-Q is also available in widths of 1800 and 2500 mm

**3.7** The tolerances of dimensions according to EN14374 at the reference moisture content of  $10 \pm 2\%$  are given in Table 3.

*Table 3. Tolerances of Kerto-products according to EN14374.*

Dimension	Size, mm	Tolerance, mm or %
Thickness	All	+ (0,8+0,03 t) mm and – (0,4+0,03 t) mm
Width	< 400	± 2,0 mm
	≥ 400	± 0,5 %
Length	All	± 5,0 mm
The angle of the cross section shall not deviate more than 1:50 (about 1,1°) from the right angle.		

*t* is thickness

The tolerances generally used by industry are presented in Table 4. These tolerances have been published in *Laminated Veneer lumber (LVL) bulletin, New European strength classes, September 2019*. The tolerances of dimensions are valid at the reference moisture content of  $10 \pm 2\%$ .

*Table 4. Tolerances of Kerto-products according to Laminated Veneer lumber (LVL) bulletin, New European strength classes, September 2019.*

Dimension	Size, mm	Tolerance, mm or %
Thickness	$t \leq 27$ mm	± 1,0 mm
	$27 < t \leq 57$ mm	± 2,0 mm
	$t > 57$ mm	± 3,0 mm
Width	< 400	± 2,0 mm
	≥ 400	± 0,5 %
Length	All	± 5,0 mm
The angle of the cross section shall not deviate more than 1:50 (about 1,1°) from the right angle.		

*t* is thickness

**3.8** Surface veneer quality and classes are given in manufacturer's product manuals.

**3.9** The Kerto products are CE-marked according to EN 14374. The Kerto products covered by this Certificate may additionally be marked with the Eurofins Product Certificate marking.

**3.10** The manufacture of Kerto products is covered by a certified quality system ISO 9001 at the Lohja and Punkaharju mills. The factory production control is regular and comprises the control of equipment, raw and incoming materials, production processes and finished products.

**3.11** The manufacturer has an agreement of certification and quality control with Eurofins Expert Services Oy. The continuous surveillance, assessment and approval of the factory production control are carried out at least twice a year.

## 4. Delivery and storage on site

**4.1** The Kerto products are delivered in plastic packages. Each delivery package is labelled with the number and dimensions of the products and the delivery address or order number.

**4.2** Kerto products should be stored only temporarily on the building site. Any measures to keep the moisture content low and to avoid condensation should be done carefully. Therefore tarpaulins should be used to protect the products from rain, dirt and excessive solar radiation. The plastic package is only intended to protect the Kerto products during delivery, and does not provide sufficient protection against weather.

Kerto products should be stored on a plane underlay using a sufficient number of supports according to manufacturer's instructions.

**4.3** Weather exposure of rain, water flowing as well as water convection from other structures should be avoided. The product may be exposed to the weather for a short period of time during installation. Products which have become wet shall be dried before use.

## DESIGN INFORMATION

### 5. General

**5.1** Kerto products are used for structural or non-structural applications in buildings and bridges.

**5.2** Kerto products can be painted or stained. The suitability of the treatment shall be checked with the treatment manufacturer.

### 6. Structural performance

**6.1** The structural performance of Kerto products is considered according to the limit state design principles specified in Eurocode 5. Alternatively, national design codes may be used if they are consistent with the Eurocodes system. In design, the methods of glued laminated timber are applied unless otherwise indicated for LVL. In addition, special methods specified in the Annexes of this certificate can be used.

**6.2** The characteristic strength and stiffness values of Kerto-S and Kerto-Q products are given in Table 5. The orientations are clarified in Figure 1. The values are compatible with the design methods mentioned above.

The characteristic strength and stiffness values are given at an equilibrium moisture content resulting from a temperature of 20 °C and a relative humidity of 65 %. The duration of load is 5 minutes.

Furthermore, the reference width (depth of the beam) in edgewise bending is 300 mm while the reference length in tensile parallel to grain is 3000 mm.

Table 5. The strength and stiffness values of Kerto-S and Kerto-Q according to manufacturer's declaration of performance.

Property	Symbol	Figure 1	Characteristic value, N/mm <sup>2</sup> or kg/m <sup>3</sup>		
			Kerto-S Thickness 21 - 90 mm	Kerto-Q Thickness 21 - 24 mm	Kerto-Q Thickness 27 - 75 mm
<b>Characteristic values</b>					
Bending strength:					
Edgewise, (depth 300 mm)	$f_{m,0,edge,k}$	A	44,0	28,0	32,0
Size effect parameter	s	-	0,12	0,12	0,12
Flatwise, parallel to grain	$f_{m,0,flat,k}$	B	50,0	32,0	36,0
Flatwise, perpendicular to grain	$f_{m,90,flat,k}$	C	-	7,0 <sup>1</sup>	8,0
Tension strength:					
Parallel to grain (length 3000 mm)	$f_{t,0,k}$	D	35,0	19,0	26,0
Perpendicular to grain, edgewise	$f_{t,90,edge,k}$	E	0,8	6,0	6,0
Perpendicular to grain, flatwise	$f_{t,90,flat,k}$	F	-	-	-
Compression strength:					
Parallel to grain	$f_{c,0,k}$	G	35,0 <sup>2</sup>	19,0 <sup>2</sup>	26,0 <sup>2</sup>
Perpendicular to grain, edgewise	$f_{c,90,edge,k}$	H	6,0	9,0	9,0
Perpendicular to grain, flatwise	$f_{c,90,flat,k}$	I	2,2	2,2	2,2
Shear strength:					
Edgewise	$f_{v,0,edge,k}$	J	4,2	4,5	4,5
Flatwise, parallel to grain	$f_{v,0,flat,k}$	K	2,3	1,3	1,3
Flatwise, perpendicular to grain	$f_{v,90,flat,k}$	L	-	0,6	0,6
Modulus of elasticity:					
Parallel to grain, along	$E_{0,k}$	ABDG	11600	8300	8800
Parallel to grain, across	$E_{90,k}$	C	-	1000 <sup>1</sup>	1700
Perpendicular to grain, edgewise	$E_{90,edge,k}$	H	350	2000	2000
Perpendicular to grain, flatwise	$E_{90,flat,k}$	I	100	100	100
Shear modulus:					
Edgewise	$G_{0,edge,k}$	J	400	400	400
Flatwise, parallel to grain	$G_{0,flat,k}$	K	270	60	100
Flatwise, perpendicular to grain	$G_{90,flat,k}$	L	-	16	16
Density	$\rho_k$		480	480	480
<b>Mean values</b>					
Modulus of elasticity:					
Parallel to grain, along	$E_{0,mean}$	ABDG	13800	10000	10500
Parallel to grain, across	$E_{90,mean}$	C	-	1200 <sup>1</sup>	2000
Perpendicular to grain, edgewise	$E_{90,edge,mean}$	H	430	2400	2400
Perpendicular to grain, flatwise	$E_{90,flat,mean}$	I	130	130	130
Shear modulus:					
Edgewise	$G_{0,edge,mean}$	J	600	600	600
Flatwise, parallel to grain	$G_{0,flat,mean}$	K	380	80	120
Flatwise, perpendicular to grain	$G_{90,flat,mean}$	L	-	22	22
Density	$\rho_{mean}$	-	510	510	510

<sup>1</sup> For the lay-up I-III-I the values 14,0; 2900 and 3300 can be used instead of 7,0; 1000 and 1200.

<sup>2</sup> In service class 2 the value 35.0 N/mm<sup>2</sup> is recommended to be divided by 1,2.

The material values in this certificate shall be used for structural calculations with EN 1995 (Eurocode 5).

 <p>A. Edgewise bending, parallel to grain (m,0,edge)</p>	 <p>B. Flatwise bending, parallel to grain (m,0,flat)</p>	 <p>C. Flatwise bending, perpendicular to grain (m,90,flat)</p>
 <p>D. Tension, parallel to grain (t,0)</p>	 <p>E. Edgewise tension, perpendicular to grain (t,90, edge)</p>	 <p>F. Flatwise tension, perpendicular to grain (t,90,flat)</p>
 <p>G. Compression, parallel to grain (c,0)</p>	 <p>H. Edgewise compression, perpendicular to grain (c,90,edge)</p>	 <p>I. Flatwise compression, perpendicular to grain (c,90,flat)</p>
 <p>J. Edgewise shear, parallel to grain (v,0,edge)</p>	 <p>K. Flatwise shear, parallel to grain (v,0,flat)</p>	 <p>L. Flatwise shear, perpendicular to grain (v,90,flat)</p>

Figure 1. Definition of strength and stiffness orientations.

**6.3** The strength classes have been introduced by European LVL producers in *Laminated Veneer lumber (LVL) bulletin, New European strength classes, September 2019*. Strength classes comprise the strength, stiffness and density values. Table 6 shows the corresponding strength classes for Kerto S and Kerto Q products.

Table 6. Corresponding LVL strength classes of Kerto products.

Kerto Product	LVL strength class
Kerto Q 21-24 mm	LVL 32 C
Kerto Q 27-75 mm	LVL 36 C
Kerto S 21-90 mm	LVL 48 P

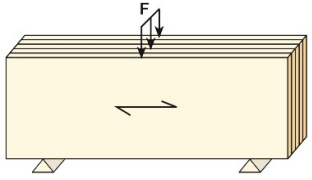
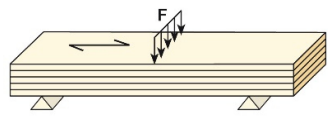
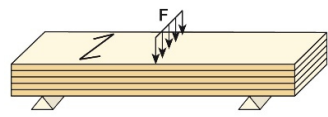
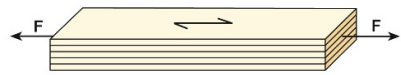
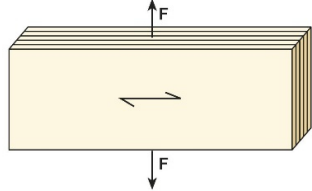
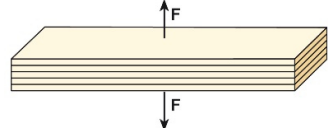
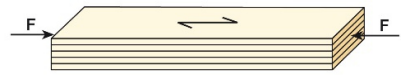
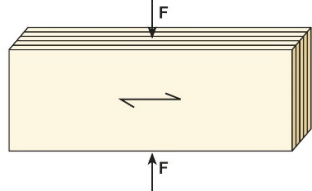
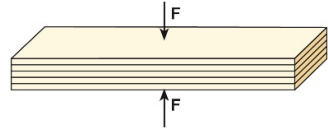
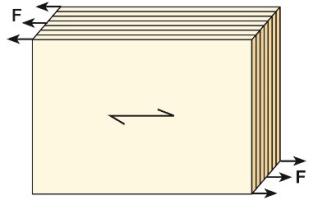
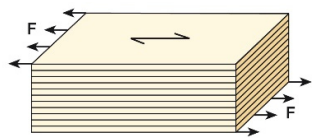
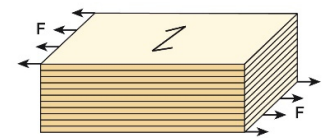
**6.4** In design, the effect of moisture content and duration of load on strength and deformation shall be taken into account by the modification factor  $k_{mod}$  and the deformation factor  $k_{def}$  as given in Eurocode 5. For Kerto-Q, flatwise, the  $k_{mod}$  and  $k_{def}$  values of plywood shall be used. For Kerto-Q, edgewise, the  $k_{mod}$  and  $k_{def}$  values of LVL shall be used. The modification factors are given in Tables 7 and 8.

Table 7. Values of  $k_{mod}$ .

Product	Service class	$k_{mod}$ in load-duration classes				
		Perma- nent action	Long term action	Medium term action	Short term action	Instanta- neous action
Kerto-S and Kerto-Q	1	0,60	0,70	0,80	0,90	1,10
	2	0,60	0,70	0,80	0,90	1,10
	3	0,50	0,55	0,65	0,70	0,90

Table 8. Values of  $k_{def}$ .

Product	Service class	$k_{def}$
Kerto-S and Kerto-Q, edgewise	1	0,60
	2	0,80
	3	2,00
Kerto-Q, flatwise	1	0,80
	2	1,00
	3	2,50

**6.5** The effect of member size on edgewise bending and tensile strength values shall be taken into account. This is made by the factors  $k_h$  and  $k_l$  given in Eurocode 5 for which the s-values are given in Table 6. The size effect factors are:

$$k_h = \min \begin{cases} (300/h)^{0,12} \\ 1,2 \end{cases}$$

$$k_l = \min \begin{cases} (3000/l)^{0,06} \\ 1,1 \end{cases}$$

where  $h$  is the cross section depth in mm and  $l$  is the member length in mm.



**6.6** The characteristic values given in Table 5 can be used without any modifications for temperatures below or equal to 50 °C for a prolonged period of time.

**6.7** Since the dimensions of Kerto products remain quite stable during temperature changes, it is not usually necessary to consider any effects of temperature variations on the structural design.

**6.8** For some applications Kerto-S and Kerto-Q members are sawn in an angle  $\alpha$  to the grain direction of the face veneers. The reduction factor on the strength and stiffness properties is given in Table 9.

*Table 9. Reduction factors for Kerto-S and Kerto-Q members sawn in an angle  $\alpha$  to grain direction of face veneers.*

	Angle $\alpha^1$								
	0°	2,5°	5°	10°	15°	30°	45°	60°	90°
<b>Kerto-S</b>									
- Bending edgewise	1,00	0,90	0,75	0,45	0,25	0,10	0,05	0,05	0,02
- Bending flatwise	1,00	0,90	0,80	0,55	0,30	0,10	0,05	0,05	0,02
- Tension parallel to grain	1,00	1,00	0,90	0,60	0,30	0,05	0,02	0,02	0,02
- Comp. parallel to grain	1,00	1,00	0,90	0,65	0,40	0,20	0,17	0,17	0,17
- Modulus of elasticity	1,00	0,90	0,80	0,60	0,40	0,15	0,05	0,05	0,03
<b>Kerto-Q</b>									
- Bending edgewise	1,00	0,90	0,75	0,55	0,40	0,25	0,20	0,20	0,22
- Bending flatwise	1,00	1,00	0,90	0,70	0,50	0,25	0,20	0,20	0,22
- Tension parallel to grain	1,00	1,00	0,90	0,70	0,40	0,25	0,20	0,20	0,23
- Comp. parallel to grain	1,00	1,00	0,90	0,70	0,50	0,35	0,25	0,25	0,35
- Modulus of elasticity	1,00	0,90	0,80	0,60	0,40	0,15	0,10	0,10	0,23

<sup>1</sup> The values for intermediate angles can be interpolated.

**6.9** In structural applications, any holes and notches to be worked out during the installation shall separately be considered and accepted by the designer. In design of beams with a notch at the support according to Eurocode 5, the following values can be used for  $k_n$ :

$$k_n = \begin{cases} 6 & \text{Kerto-S, edge} \\ 16 & \text{Kerto-Q, edge} \end{cases}$$

**6.10** The design of holes of Kerto structural members is presented in Annex A.

**6.11** Kerto members shall be designed in such a way that width and thickness changes due to moisture content variation do not cause harmful stresses in the structures. Special attention shall be paid to the design of joints.

**6.12** The design of dowel-type joints of Kerto structural members is presented in Annexes B and C.

**6.13** During installation, the temporary bracing of the structure shall be considered by the designer.

**6.14** In design of compression perpendicular to grain, the contact length can be increased as specified in Table 10. Furthermore, the  $k_{c,90}$  factor can be used, Table 10.

Table 10. Contact length and  $k_{c,90}$  factor.

Compression	Increasing of contact length <sup>(1)</sup>	$k_{c,90}$ <sup>(2)</sup>	
		(a)	(b)
Kerto-S, edgewise	15 mm along	1,0	$\leq 1,2$ <sup>(4)</sup>
Kerto-S, flatwise <sup>(3)</sup>	30 mm along 15 mm across	1,4	1,6
Kerto-Q, edgewise	15 mm along	1,0	1,0
Kerto-Q, flatwise <sup>(3)</sup>	30 mm along 15 mm across	1,4	1,6

<sup>1</sup> The actual contact length is increased at each side by this distance, but not more than  $a$ ,  $l$  or  $l_1/2$  according to Eurocode 5.

Along = contact length parallel to the grain direction of face veneers.

Across = contact length perpendicular to the grain direction of face veneers.

<sup>2</sup> Member on (a) continuous or (b) discrete supports provided that  $l_1 \geq 2h$  according to Eurocode 5.

<sup>3</sup> Provided a compression deformation of 20 % is acceptable for  $h < 45$  mm

<sup>4</sup> For Kerto-S edgewise at discrete supports (b):

$$k_{c,90} = \begin{cases} 1,2 & l \geq 100\text{mm} \\ 1,4 - \frac{l}{500} & 100\text{mm} \leq l \leq 200\text{mm} \\ 1,0 & l \geq 200\text{mm} \end{cases}$$

## 7. Performance in relation to moisture

**7.1** On delivery, the moisture content  $\omega$  of Kerto products is about 8 - 10 %. Due to changes in temperature and relative humidity of the surrounding air, the moisture content will continuously change. In service class 1 the moisture content usually varies between 6 and 10 %, while in service class 2 it usually varies between 10 and 16 %.

Moisture content  $\omega$  is defined as follows:

$$\omega = \frac{m_{\omega} - m_0}{m_0}$$

where  $m_{\omega}$  is the mass of the product corresponding moisture content  $\omega$  and  $m_0$  is the dry mass of the product.

**7.2** Kerto products swell when the moisture content increases, and shrink when the moisture content decreases. The extent of these dimensional changes depends on the grain direction. Wetting causes permanent deformations, problems with surface veneers and falling of knots.

The formula to calculate the dimensional change  $\Delta L$  of a Kerto product due to change of moisture content is:

$$\Delta L = \Delta \omega \cdot \alpha_H \cdot L$$

where  $\Delta \omega$  is change of moisture content in %,  $\alpha_H$  dimensional variation coefficient and  $L$  dimensional length. The dimensional variation coefficients are given in Table 11.

Table 11. Dimensional variation coefficients.

	Kerto-S	Kerto-Q
Thickness	0,0024	0,0024
Width	0,0032	0,0003
Length	0,0001	0,0001

**7.3** Water vapour resistance factor  $\mu$  and water vapour diffusion coefficient  $\delta_p$  for Kerto products are given in Table 12.

Table 12. Water vapour resistance factor  $\mu$  and water vapour diffusion coefficient  $\delta_p$ .

	Conditions	$\mu$ (-)		$\delta_p$ (kg/Pa s m)	
		Kerto-S	Kerto-Q	Kerto-S	Kerto-Q
Thickness direction	Dry Cup <sup>1</sup>	200	200	$1,0 \cdot 10^{-12}$	$1,0 \cdot 10^{-12}$
	Wet Cup <sup>2</sup>	70	70	$2,7 \cdot 10^{-12}$	$2,7 \cdot 10^{-12}$
	20°C-50/75RH%	80	62	$2,4 \cdot 10^{-12}$	$3,0 \cdot 10^{-12}$
Width direction	20°C-50/75RH%	82	9,5	$2,3 \cdot 10^{-12}$	$20 \cdot 10^{-12}$
Length direction	20°C-50/75RH%	3,9	4,7	$49 \cdot 10^{-12}$	$40 \cdot 10^{-12}$

<sup>1</sup> Dry cup values tested in 23°C - 0/50 RH% conditions.

<sup>2</sup> Wet cup values tested in 23°C - 50/93 RH% conditions.

## 8. Performance in case of fire

**8.1** The fire resistance of a Kerto product is considered according to Eurocode 5 as follows:

The notional design charring depth  $d_{char,0}$  in one-dimensional charring shall be calculated as

$$d_{char,0} = \beta_0 t$$

where  $t$  is the relevant time of fire exposure and  $\beta_0$  is the basic design charring rate for one-dimensional charring at standard fire exposure.  $\beta_0$  for Kerto products is 0,65 mm/min.

The notional design charring depth  $d_{char,n}$ , including the effect of corner roundings and fissures, shall be calculated as

$$d_{char,n} = \beta_n t$$

where  $t$  is the relevant time of fire exposure and  $\beta_n$  is the notional design charring rate, including the effect of corner rounding and fissures.  $\beta_n$  for Kerto products is 0,70 mm/min.

In addition to the fire resistance of the Kerto members, the designer shall consider the fire resistance of the joints.

**8.2** Reaction to fire classes of Kerto products without surface treatment according to manufacturer's declaration of performance are presented in Table 13.

*Table 13. Reaction to fire classes of Kerto products without surface treatment.*

End use condition	Minimum thickness (mm)	Class (excluding floorings)	Class (floorings)
- Any substrate or air gap behind the product	21	D-s2, d0	D <sub>fl</sub> -s1
- With or without an air gap between the product and a substrate of class A1 or A2-s1,d0, thickness of at least 6 mm and density of at least 800 kg/m <sup>3</sup> - Fixed mechanically to wooden or metallic frames	27	D-s1, d0	-
- Free standing applications	27	D-s1, d0	-

**8.3** The heat of combustion of Kerto products is 17 MJ/kg.

**8.4** Kerto products treated against fire are not covered by this certificate.

## **9. Hygiene, health and environmental performance**

**9.1** Outdoor use or use in high relative humidity conditions may cause mould growth on the surface of Kerto products. If these kinds of conditions are expected during erection, a brushable or sprayable surface treatment should be used. This kind of treatment has no adverse effects to the structural properties of Kerto products

**9.2** If, due to excessive wetting, there is mould growth on the surface of Kerto products, this shall be removed by sanding.

**9.3** The formaldehyde class of Kerto products is E1, according to manufacturer's declaration of performance.

## **10. Thermal insulation performance**

**10.1** The thermal conductivity of Kerto products is 0,13 W/(m K), according to tabulated values in EN ISO 10456.

## 11. Durability

**11.1** The adhesive and glue bond used for Kerto products is suitable for service classes 1, 2 and 3. The biological durability of Kerto products is DC5 (not durable) based on spruce sapwood classification according to EN 350. Therefore Kerto products can be used in service classes 1 and 2 as defined in Eurocode 5, which correspond to the use classes 1 and 2 as defined in EN 335. The Kerto products should not be used in service class 3 without additional protective treatment. The designer shall pay attention to the details of the construction and to ensure that no water pockets will be formed.

During the erection of the building, Kerto products and structures resist well temporary exposure to water without decay, provided that they are allowed to dry afterwards.

**11.2** When necessary and required by the local authorities at the building site, Kerto products can be preservative impregnated against biological attack according to the rules valid on the place. Preservative impregnated Kerto products are not covered by this certificate. Any adverse effects of the preservative impregnation on other properties shall be taken into account according to a separate clarification.

## INSTRUCTIONS FOR INSTALLATION AND USE

### 12. Manufacturer's instructions

**12.1** Kerto products shall be handled carefully to protect them from damage and dirt.

**12.2** Kerto products can be processed using conventional woodworking tools, e.g. sawing, planing, drilling, nailing and screwing.

**12.3** General guidelines of timber constructions shall be followed in installations and use of Kerto products.

**12.4** After use, Kerto products shall be disposed of according to national regulations and directives. In general, the products can be reused, composted or burned.

## TECHNICAL SURVEY

### 13. Initial assessment

**13.1** The manufacturer has declared the following properties, manufacturer's declarations of performance, no. MW/LVL/311-001/CPR/DOP and MW/LVL/312-001/CPR/DOP.

- Modulus of elasticity and shear modulus
- Strength
- Density
- Glue bond quality
- Reaction to fire class
- Formaldehyde class
- Natural durability against biological attack

## VALIDITY OF THE CERTIFICATE

### 14. Validity period of the certificate

This certificate is valid until August 27, 2025.

### 15. Conditions of validity

The certificate is valid assuming that no fundamental changes are made to the product, and that the manufacturer has a valid contract on certification.

### 16. Other conditions

The references made in this certificate to standards and instructions are valid in the format used at the time the certificate was signed.

The recommendations in this certificate concerning the safe use of this product are minimum requirements that shall be satisfied when using the product. The certificate does not override current or future requirements imposed by laws and statutes. In addition to the issues presented in this certificate, design, manufacturing and use shall follow appropriate construction methods.

The manufacturer is in charge of the product's quality and factory production control. In awarding this certificate, Eurofins Expert Services Oy does not bind itself to indemnification liability concerning personal injury or other damage that may directly or indirectly result from using the product described in this certificate.

This certificate is the English version of the original EUFI29-20000676-C certificate in Finnish. In case of dispute the original certificate is valid.

This updated certificate no. EUFI29-20000676-C/EN has been awarded as described above to Metsäliitto Cooperative, Metsä Wood Oy.

On behalf of Eurofins Expert Services Oy on August 27, 2020

Tiina Ala- Outinen  
Manager, Certification and Inspection

Jouni Hakkarainen  
Leading Expert

*This document has been signed electronically*

## ANNEX A: DESIGN OF HOLES

### General

Design rules for circular and rectangular holes are given. Symbols related to holes are given in Figures A1 and A2. Other symbols are defined in the text.

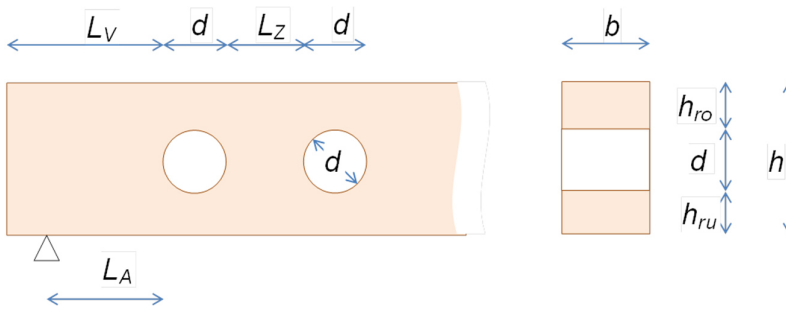

Figure A1. Symbols related to circular holes.

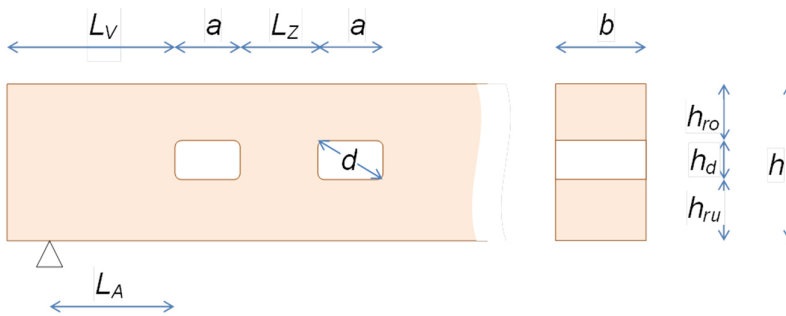

Figure A2. Symbols related to rectangular holes.

### Small holes

In design of beams with circular holes with a diameter  $d/h \leq 0,15$  and  $d \leq 50$  mm located close to the neutral axis it is sufficient to use a reduced cross section when bending, tension, compression and shear stresses are calculated.

In design of beams with rectangular holes with a height  $h_d/h \leq 0,10$  and  $h_d \leq 35$  mm and a length  $a/h \leq 0,10$  and  $a \leq 35$  mm located close to the neutral axis it is sufficient to use a reduced cross section when bending, tension, compression and shear stresses are calculated.

## Kerto-S beams with holes

This design method can be used when the requirements given in Equations A1 - A10 are fulfilled.

For circular and rectangular holes:

$$L_v \geq h \quad (A1)$$

$$L_A \geq 0,5h \quad (A2)$$

Additionally for circular holes:

$$d \leq 0,7h \quad (A3)$$

$$h_{ro} \text{ ja } h_{ru} \geq 0,15h \quad \text{when hole centre located at neutral axis} \quad (A4)$$

$$h_{ro} \text{ ja } h_{ru} \geq 0,25h \quad \text{when hole centre not located at neutral axis} \quad (A5)$$

$$L_z \geq \max \begin{cases} 0,5h \\ 2,0d \end{cases} \quad (A6)$$

Additionally for rectangular holes:

$$a \leq 1,3h \quad (A7)$$

$$h_d \leq 0,3h \quad (A8)$$

$$h_{ro} \text{ ja } h_{ru} \geq 0,35h \quad (A9)$$

$$L_z \geq 1,5h \quad (A10)$$

Furthermore, for rectangular holes the radius of curvature at each corner shall be at least 15 mm.

The design criterion for both circular and rectangular holes is

$$\sigma_{t,90,d} = \frac{F_{t,90,d}}{0,5bl_{t,90}} \leq 0,85k_{hole}k_{space}k_{t,90}f_{t,90,d} \quad (A11)$$

where  $\sigma_{t,90,d}$  is the design tension stress perpendicular to grain and  $f_{t,90,d}$  is the design tension strength perpendicular to grain. The length  $l_{t,90}$  is given by

$$l_{t,90} = 0,35d + 0,5h \quad \text{for circular holes} \quad (A12)$$

$$l_{t,90} = 0,5h_d + 0,5h \quad \text{for rectangular holes} \quad (A13)$$

For both circular and rectangular holes the reduction factor  $k_{t,90}$  is given by

$$k_{t,90} = \min \begin{cases} 1 \\ (450/h)^{0,5} \end{cases} \quad (A14)$$

where  $h$  is given in mm.



The reduction factor  $k_{hole}$  is given by

$$k_{hole} = \min \begin{cases} 1 & \text{for circular holes} \\ 1 - 1,5 \frac{d - 0,5h}{0,5h} & \end{cases} \quad (\text{A15})$$

$$k_{hole} = 1 \quad \text{for rectangular holes} \quad (\text{A16})$$

The reduction factor  $k_{space}$  is given by

$$k_{space} = \min \begin{cases} 1 & \text{for circular holes} \\ 1 - 0,8 \frac{h - L_z}{h} & \\ 1 - 0,8 \frac{4d - L_z}{4d} & \end{cases} \quad (\text{A17})$$

$$k_{space} = 1 \quad \text{for rectangular holes} \quad (\text{A18})$$

The design tension load resultant  $F_{t,90,d}$  is given by

$$F_{t,90,d} = \frac{V_d h_d}{4h} \left( 3 - \frac{h_d^2}{h^2} \right) + 0,008 \frac{M_d}{h_r} \quad (\text{A19})$$

where  $V_d$  is the design shear force and  $M_d$  is the design moment both acting at the hole edge. For circular holes  $h_d$  can be replaced by  $0,7d$ . The distance  $h_r$  is given by

$$h_r = \min \begin{cases} h_{ro} + 0,15d \\ h_{ru} + 0,15d \end{cases} \quad \text{for circular holes} \quad (\text{A20})$$

$$h_r = \min \begin{cases} h_{ro} \\ h_{ru} \end{cases} \quad \text{for rectangular holes} \quad (\text{A21})$$

In addition to the design criterion for holes, Equation A11, the bending, tension, compression and shear stresses of the beam calculated for the reduced cross section shall be verified at the holes.

In case that the hole centre is located at the neutral axis ( $h_{ro} = h_{ru}$ ) the design bending stress is given by

$$\sigma_{m,d} = \frac{M_d h}{2I_{red}} + \sigma_{add,d} \quad (\text{A22})$$

where  $M_d$  is the design moment calculated at the centre of the hole.  $I_{red}$  is given by

$$I_{red} = \frac{b}{12}(h^3 - d^3) \quad \text{for circular holes} \quad (\text{A23})$$

$$I_{red} = \frac{b}{12}(h^3 - h_d^3) \quad \text{for rectangular holes} \quad (\text{A24})$$

$\sigma_{add,d}$  is given by

$$\sigma_{add,d} = 0 \quad \text{for circular holes} \quad (\text{A25})$$

$$\sigma_{add,d} = \frac{M_{add,d}}{W_{ro}} = \frac{V_d a / 4}{b h_{ro}^2 / 6} = \frac{3V_d a}{2b h_{ro}^2} \quad \text{for rectangular holes} \quad (\text{A26})$$

where  $V_d$  is the design shear force at the centre of the hole.

In case that the hole centre is located at the neutral axis ( $h_{ro} = h_{ru}$ ) the design tension  $\sigma_{t,d}$  and compression  $\sigma_{c,d}$  stresses are given by

$$\sigma_{t,d} = \frac{F_{t,d}}{A_{red}} \quad (\text{A27})$$

$$\sigma_{c,d} = \frac{F_{c,d}}{A_{red}} \quad (\text{A28})$$

where  $F_{t,d}$  and  $F_{c,d}$  are the design tension and compression force at the centre of the hole.  $A_{red}$  is given by

$$A_{red} = b(h - d) \quad \text{for circular holes} \quad (\text{A29})$$

$$A_{red} = b(h - h_d) \quad \text{for rectangular holes} \quad (\text{A30})$$

In case that the centre of a round hole is located at the neutral axis ( $h_{ro} = h_{ru}$ ) the design shear stress is given by

$$\sigma_{v,d} = \frac{1,5V_d}{A_{red}} \quad (\text{A31})$$

where  $V_d$  is the design shear force at the centre of the hole.  $A_{red}$  is given in Equations A29 and A30.

In case that the centre of a rectangular hole is located at the neutral axis ( $h_{ro} = h_{ru}$ ) the design shear stress is given by

$$\sigma_{v,d} = k_\tau \frac{1,5V_d}{A_{red}} \quad (\text{A32})$$

where  $V_d$  is the design shear force at the hole edge and  $k_\tau$  is a factor to determine the maximum shear stress given by

$$k_{\tau} = 1,85 \left( 1 + \frac{a}{h} \right) \left( \frac{h_d}{h} \right)^{0,2} \quad (\text{A33})$$

### **Kerto-Q beams with holes**

This design method can be used when the requirements given in Equations A1 - A10 are fulfilled. Furthermore, for rectangular holes the radius of curvature at each corner shall be at least 15 mm.

The tension strength perpendicular to grain of Kerto-Q is high enough to prevent any possible initial crack growth to propagate to failure. Thus, the design criterion given in Equation A11 is not relevant. For Kerto-Q beams with holes the bending, tension, compression and shear stresses of the beam calculated for the reduced cross section shall be verified at the holes. The bending, tension, compression and shear stresses are given in Equations A22, A27, A28, A31 and A32.

## ANNEX B: DESIGN OF LATERALLY LOADED DOWEL-TYPE CONNECTIONS

### General

The principles given for the structural design of laterally loaded dowel-type connections in the EN 1995-1-1+A1:2008+A2:2014 (Eurocode 5) can be applied to Kerto-LVL with the following additional or substitutive design values and criteria concerning the characteristics of Kerto-S and Kerto-Q. This annex deals with flatwise and edgewise Kerto-LVL joints. In the flatwise connections the direction of fasteners is perpendicular to the surface of veneers, while in the edgewise connections the fasteners are parallel to the veneers and perpendicular to the grain direction of the face veneers ("edge joint").

For Kerto-to-Kerto or Kerto-to-steel connections, the value  $\gamma_M = 1,2$  may be used as the partial factor of connection resistance in ultimate limit states for the fundamental combinations unless a specified value has not been given in the relevant National Annex of EN 1995-1-1.

Equation (8.4) of EN 1995-1-1 is not applied with flatwise connections of Kerto-Q. Due to the cross-veneers, Kerto-Q is not sensitive to splitting with a force perpendicular to the grain.

### Nailed connections

The rules given for nailed timber connections in Eurocode 5 apply to Kerto-LVL with the following additions.

In edgewise Kerto-Q connections the embedment strength  $f_{h,k}$  of clause 8.3.1.1(5) shall be multiplied by a decreasing factor:

$$\max\left\{1 - \frac{2}{d}; \frac{1}{3}\right\}$$

where  $d$  is the nail diameter in mm. However, for nailed edgewise connections loaded perpendicular to the grain ( $\alpha = 90^\circ$ ), the embedment strength is not needed to reduce.

For flatwise Kerto-Q connections, clause 8.3.1.1(8) is disregarded. The nails may be placed to the straight rows in Kerto-Q without any number reduction of fasteners in the calculations of the load-carrying capacity.

For edgewise connections the factor  $k_{ef}$  used in equation (8.17) of EN 1995-1-1 should be calculated by the following expression:

$$k_{ef} = \min \left\{ 0,4 + 0,03 \frac{a_1}{d}; 1 \right\}$$

The minimum values of nail spacings and distances given in the column  $\rho_k \leq 420 \text{ kg/m}^3$  of Table 8.2 in Eurocode 5 may be used for flatwise Kerto-S connections without predrilled holes.

For edgewise connections the minimum values of nail spacing and distances given for the timber density  $420 \leq \rho_k \leq 500 \text{ kg/m}^3$  in Eurocode 5 should be used. In edgewise connections loaded perpendicular to the grain ( $\alpha = 90^\circ$ ), the following reduced distances may be used for nails with a diameter  $d < 5 \text{ mm}$ :

- the minimum distance of loaded edge  $a_{4,t}$  may be reduced up to  $7d$  provided, that the lateral load carrying capacity of the fastener  $F_{v,Rk}$  is multiplied by a factor:

$$k_{a,4} = \min \left\{ \frac{a_{4,t}}{9d}; 1 \right\}$$

- the minimum nail spacing parallel to the grain  $a_1$  may be reduced up to  $5d$  provided, that the lateral load carrying capacity of the fastener  $F_{v,Rk}$  is multiplied by a factor:

$$k_{a,1} = \min \left\{ \frac{a_1 + 7d}{14d}; 1 \right\}$$

For flatwise Kerto-Q connections nailed without predrilled holes, the following minimum values of spacings and edge and end distances may be used (clause 8.3.1.2(5)):

$$a_1 = (5 + 2|\cos \alpha|)d$$

$$a_2 = 5d$$

$$a_{3,t} = (4 + 3|\cos \alpha|)d$$

$$a_{3,c} = 4d$$

$$a_{4,t} = (3 + 4|\sin \alpha|)d$$

$$a_{4,c} = 3d$$

Clause 8.3.1.2(6) or 8.3.1.2(7) in Eurocode 5 is not needed to take into account with flatwise connections of Kerto-Q. The minimum thickness of Kerto-Q is not limited for nails without predrilled holes. For flatwise Kerto-

S connections, clause 8.3.1.2(6) is applied and clause 8.3.1.2(7) is disregarded. Clause 8.3.1.2(7) is applied for the edgewise connections.

### Stapled connections

The rules given for stapled connections in Eurocode 5 may be applied for laterally loaded stapled connections of Kerto-LVL. The design load-carrying capacity per staple should be considered as equivalent to that of two nails in corresponding flatwise or edgewise Kerto-LVL connection according to clause 8.4(5) of Eurocode 5.

### Bolted and dowelled connections

The rules given for bolted and dowelled timber connections in Eurocode 5 may be applied with Kerto-LVL with the following additions and replacements.

For Kerto-Q, clause 8.5.1.1(2) of Eurocode 5 is replaced by the following expression:

For bolts and dowels up to 30 mm diameter, the following characteristic embedment strength values of Kerto-Q should be used, at an angle  $\alpha$  to the grain

$$f_{h,\alpha,k} = \begin{cases} \frac{f_{h,0,k}}{k_{90} \sin^2 \alpha + \cos^2 \alpha} & \text{when } 0^\circ \leq \alpha < 45^\circ \\ \frac{2}{k_{90} + 1} \cdot f_{h,0,k} & \text{when } 45^\circ \leq \alpha \leq 90^\circ \end{cases}$$

$$f_{h,0,k} = 37 k_Q (1 - 0,01d)$$

where:

$$k_Q = \begin{cases} 1 & \text{for flatwise connections} \\ 1 - \frac{2}{d} \leq 0,87 & \text{for edgewise connections} \end{cases}$$

$$k_{90} = 1,15 + 0,015d$$

$f_{h,0,k}$  is the characteristic embedment strength parallel to the grain of outer veneers, in N/mm<sup>2</sup>;

$\alpha$  is the angle of the load to the grain of outer veneers;

$d$  is the fastener diameter, in mm.

For bolted and dowelled Kerto-S and edgewise Kerto-Q connections, the following minimum values for the fastener spacing parallel to grain  $a_1$  and for the end distance of loaded end  $a_{3,t}$  should be used (Tables 8.4 and 8.5 in Eurocode 5):

$$a_1 = (4 + 3|\cos \alpha|)d \quad ^1)$$

$$a_{3,t} = \max \begin{cases} 7d \\ 105 \text{ mm} \end{cases} \quad ^2)$$

- 1) The minimum spacing may be further reduced to  $5d$  if the embedment strength  $f_{h,0,k}$  is reduced by a factor:  $\sqrt{\frac{a_1}{(4 + 3|\cos \alpha|)d}}$ .
- 2) For  $d < 15$  mm, the minimum end distance may be further reduced to  $7d$  if the embedment strength  $f_{h,0,k}$  is reduced by a factor:  $\frac{a_{3,t}}{105 \text{ mm}}$ .

For bolted and dowelled flatwise Kerto-Q connections, the minimum values of spacings and edge and end distances presented in Table B.1 may be used (Eurocode 5 clauses 8.5.1.1(3) and 8.6(3)). For bolted and dowelled moment resisting multi shear Kerto-to-Kerto flatwise connections with circular patterns of fasteners, the minimum values of distances and spacings presented in Table B.2 may be used.

*Table B.1 Minimum distances and spacings for bolts and dowels in flatwise Kerto-Q connections.*

Spacings and end/edge distances	Bolted Kerto-Q connection	Dowelled Kerto-Q connection
$a_1$ (parallel to grain)	$4d$	$(3+ \cos \alpha )d$
$a_2$ (perpendicular to grain)	$4d$	$3d$
$a_{3,t}$ (loaded end)	$\max(4d; 60 \text{ mm})$ *)	$\max(4d; 60 \text{ mm})$ *)
$a_{3,c}$ (unloaded end)	$4d$	$(3+ \sin \alpha )d$
$a_{4,t}$ (loaded edge)	$\max\{(2+2 \sin \alpha )d; 3d\}$	$\max\{(2+2 \sin \alpha )d; 3d\}$
$a_{4,c}$ (unloaded edge)	$3d$	$3d$
*) For $d < 15$ mm, the minimum end distance may be further reduced to $4d$ if the embedment strength $f_{h,0,k}$ is reduced by the factor $a_{3,t}/(60 \text{ mm})$		

*Table B.2 Minimum distances and spacings for bolts and dowels with circular patterns of fasteners.*

Spacings and end/edge distances	Kerto-S to Kerto-Q <sup>1)</sup>	Kerto-S to Kerto-S	Kerto-Q to Kerto-Q
End distance	6d in Kerto-S 4d in Kerto-Q	7d	4d
Edge distance	4d in Kerto-S 3d in Kerto-Q	4d	3d
Spacing on a circular	5d	6d	4d
Spacing between circulars <sup>2)</sup>	5d	5d	4d
<sup>1)</sup> when Kerto-Q is used as outer members			
<sup>2)</sup> between radius of the circulars			

## Timber failure capacity of joint area

The following guidelines apply to laterally loaded bolted and dowelled Kerto-LVL connections with a force component parallel to grain and they replace clauses 8.1.2(4)-(5) and 8.5.1.1(4) and Annex A of EN 1995-1-1 (effective number of fasteners and block/plug shear failure). These rules are applied both for timber-to-timber and steel-to-timber joints.

To take account of the possibility of splitting or shear or tension failure of the joint area caused by the force component parallel to grain  $F_{0,Ed}$ , the following expression should be satisfied

$$F_{0,Ed} \leq F_{0,Rd} = \frac{k_{mod}}{\gamma_M} F_{0,Rk} \quad (B.1)$$

where  $F_{0,Rk}$  is the characteristic timber failure capacity of the joint area calculated according to the following simplified method or by the equation (B.2).

### **Simplified method**

This simplified method may be used instead of the general analysis for flatwise Kerto-LVL connections provided that:

- number of fasteners  $n \leq 25$  ;
- number of fasteners in line parallel to grain  $n_1 \leq 5$  ;
- thickness of all the Kerto lamellas  $t_i \geq 3d$  and in steel-to-timber joints the thickness of middle Kerto lamellas  $t_2 \geq 5d$  ;
- dowel spacing perpendicular to grain  $a_2 \geq 3,5d$  ;
- tension strength of faster utilized in design  $f_{u,k} \leq 800 \text{ N/mm}^2$ ;



- load carrying capacities of steel-to-timber connections are calculated by the equations of a thin steel plate;
- the rope effect  $F_{ax,Rk}/4$  is not utilized in the design of bolted steel-to-timber connections.

The characteristic timber failure capacity of joint area

$$F_{0,Rk} = n_{1,ef} n_2 F_{v,Rk}$$

where:

$n_2$  is the maximum number of fasteners in fastener rows perpendicular to grain (see Figure B.1);

$F_{v,Rk}$  is the characteristic load-carrying capacity per fastener in loading parallel to grain.

The effective number of fasteners in rows parallel to grain

$$n_{1,ef} = \min \left\{ \begin{array}{l} n_1 \\ n_1^{0,9} \sqrt{\frac{a \cdot t}{50 \cdot d^2}} \end{array} \right.$$

with:

$$a = \min(a_1; a_3)$$

$$t = \begin{cases} \min(t_1; t_2) & \text{for single shear connections} \\ \min(2t_1; t_2) & \text{for double/multiple shear timber - to - timber joints} \\ \min(t_{1,ef}; t_2) & \text{for double/multiple shear steel - to - timber joints} \end{cases}$$

$$t_{1,ef} = \min \left\{ t_1; 2 \cdot \sqrt{\frac{M_{y,Rk}}{f_{h,0,k} \cdot d}} \right\}$$

where:

$n_1$  is the mean number of fasteners in the rows parallel to grain ( $n_1 = n/n_2$ );

$d$  is the fastener diameter ;

$a_1$  is the spacing between fasteners in grain direction ;

$a_3$  is the end distance ;

$t_1, t_2$  is the timber thickness according to Figures 8.2 and 8.3 of Eurocode 5

Note: in multiple shear connections  $t_1$  is the minimum thickness of side lamellas and  $t_2$  is the minimum thickness of middle lamellas ;

$M_{y,Rk}$  is the characteristic fastener yield moment ;

$f_{h,0,k}$  is the characteristic embedment strength parallel to the grain in timber member  $t_1$ .

### General analysis

The characteristic timber failure capacity of the joint area

$$F_{0,Rk} = \sum_{i=1}^m F_{i,0,Rk} \quad (B.2)$$

when  $F_{i,0,Rk}$  is the timber failure capacity for lamella  $i$  of the Kerto-LVL member calculated according to equation (B.3) and  $m$  is the number of joint lamellas in the Kerto-LVL member.

Timber failure capacity for the lamella  $i$  should be taken as

$$F_{i,0,Rk} = F_{ip,Rk} + F_{cp,Rk} \quad (B.3)$$

The capacity of **inner parts of lamellas**

$$F_{ip,Rk} = \begin{cases} \min\{A_{h,ip} f_{h,0,k}; F_{tv,k}\} & \text{in tension joints} \\ \min\{A_{h,ip} f_{h,0,k}; F_{cv,k}\} & \text{in compression joints} \end{cases} \quad (B.4)$$

where:

$f_{h,0,k}$  is the characteristic embedment strength of Kerto-LVL parallel to grain;

$$A_{h,ip} = (n - n_1) d t_i \quad (B.5)$$

$$F_{cv,k} = F_{v,k} + (n_2 - 1) d t_{ef,i} f_{h,0,k} \quad (B.6)$$

$$F_{tv,k} = \begin{cases} F_{t,k} \left(1 - 0,3 \frac{F_{t,k}}{F_{v,k}}\right) & \text{when } F_{t,k} \leq F_{v,k} \\ F_{v,k} \left(1 - 0,3 \frac{F_{v,k}}{F_{t,k}}\right) & \text{when } F_{v,k} < F_{t,k} \end{cases} \quad (B.7)$$

when:

$$F_{t,k} = 1,7 n_1^{-0,1} A_{t,ip} f_{t,0,k} \quad (B.8)$$

$$F_{v,k} = k_v n_1^{-0,1} A_{v,ip} f_{v,k} \quad (B.9)$$

$n$  is the number of fasteners ;

$n_1$  is the mean number of fasteners in the rows parallel to the grain ( $n_1 = n/n_2$ ) ;

$d$  is the fastener diameter ;

$t_i$  is the lamella thickness  $\leq$  penetration of the fastener ;

$n_2$  is the maximum number of fasteners in fastener rows perpendicular to the grain (see Figure B.1) ;

$f_{t,0,k}$  is the characteristic tension strength of Kerto-LVL without length factor ;

$f_{v,k}$  is the characteristic shear strength of Kerto-LVL; for flatwise connections  $f_{v,k} = f_{v,0,edge,k}$  and for edgewise connections  $f_{v,k} = f_{v,0,flat,k}$  ;

$$k_v = \begin{cases} 0,7 & \text{for Kerto -S and edgewise Kerto -Q} \\ 1,0 & \text{for flatwise Kerto -Q connections} \end{cases}$$

$$t_{ef,i} = \begin{cases} 0,68 d \sqrt{\frac{f_y}{f_{h,0,k}}} \leq t_i & \text{for side lamellas} \\ 1,63 d \sqrt{\frac{f_y}{f_{h,0,k}}} \leq t_i & \text{for middle lamellas} \end{cases} \quad (B.10)$$

$$A_{t,ip} = (n_2 - 1)(a_2 - d)t_i \quad (B.11)$$

$$A_{v,ip} = 2(n_2 - 1)((n_1 - 1)a_1 + a_{3,l})t_{ef,i} \quad (B.12)$$

where:

$f_y$  is the yield strength of the fastener ;

$a_1$  is the fastener spacing parallel to grain ;

$a_2$  is the fastener spacing perpendicular to grain ;

$a_3$  is the end distance.

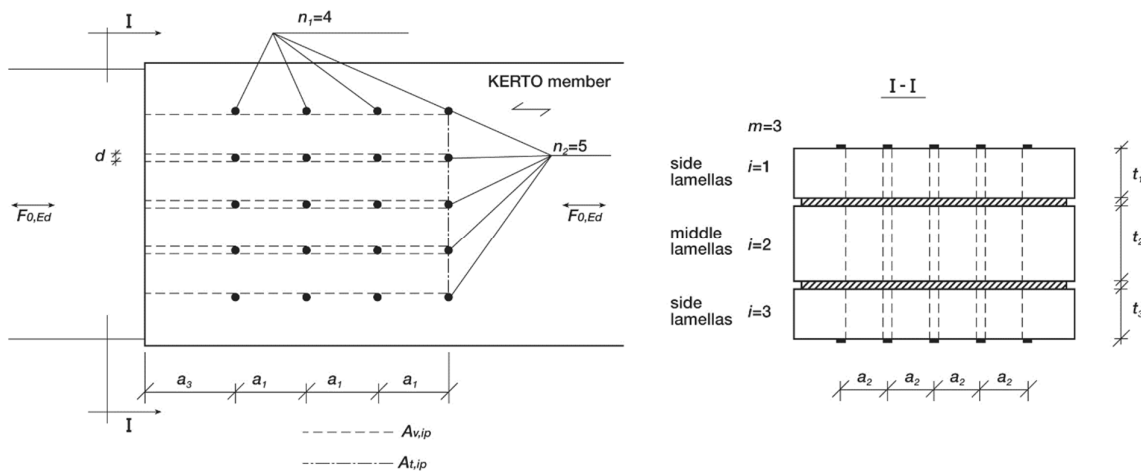

Figure B.1. Definition of symbols for the inner parts of lamellas.

**The capacity of edge parts of lamellas**

$$F_{ep,Rk} = \begin{cases} \min\{A_{h,ep}f_{h,0,k}; F_{tv,k}; F_{sv,k}; F_{sc,k}\} & \text{in tension joints} \\ \min\{A_{h,ep}f_{h,0,k}; F_{cv,k}\} & \text{in compression joints} \end{cases} \quad (B.13)$$

where:

$$A_{h,ep} = n_1 dt_i \quad (B.14)$$

$$F_{cv,k} = F_{v,k} + dt_{ef,i} f_{h,0,k} \quad (B.15)$$

$$F_{sv,k} = \begin{cases} F_{s,k} \left(1 - 0,3 \frac{F_{s,k}}{F_{v,k}}\right) & \text{when } F_{s,k} \leq F_{v,k} \\ F_{v,k} \left(1 - 0,3 \frac{F_{v,k}}{F_{s,k}}\right) & \text{when } F_{v,k} < F_{s,k} \end{cases} \quad (B.16)$$

and  $F_{tv,k}$  is calculated according to the equations (B.7) - (B.9) with substitutions  $A_{t,ep} = k_{t,ep} A_{t,ep}$  and  $A_{v,ep} = A_{v,ep}$ :

$$A_{t,ep} = (2a_4 - d)t_i \quad (\text{see Figure B.2}) \quad (B.17)$$

$$A_{v,ep} = 2((n_1 - 1)a_1 + a_3)t_{ef,i} \quad (B.18)$$

$$k_{t,ep} = \frac{1}{1 + \frac{A_{t,ep}}{A_{v,ep}}} \quad (B.19)$$

when  $a_4$  is edge distance.

In equations (B.13) and (B.16), the splitting capacities

$$F_{s,k} = \frac{14n_1^{0,9}}{s_{hole}} t_{ef,i} (a_3 - 0,5d) f_{t,90,k} \quad (B.20)$$

$$F_{sc,k} = \frac{14n_1^{0,9}}{s_{end}} t_{ef,i} (a_3 - 0,5d) f_{t,90,k} \quad (B.21)$$

where:

$f_{t,90,k}$  is the characteristic tension strength of Kerto-LVL perpendicular to the grain; for flatwise connections  $f_{t,90,k} = f_{t,90,edge,k}$  and for edgewise connections value  $f_{t,90,k} = 0,4$  N/mm<sup>2</sup> may be used;

$$s_{hole} = \max \begin{cases} 1 \\ 0,65 \frac{a_3}{a_4} \end{cases} \quad (B.22)$$

$$s_{\text{end}} = \frac{2,7}{\cosh\left(\frac{a_3}{a_4} - 1,4\right)} \quad (\text{B.23})$$

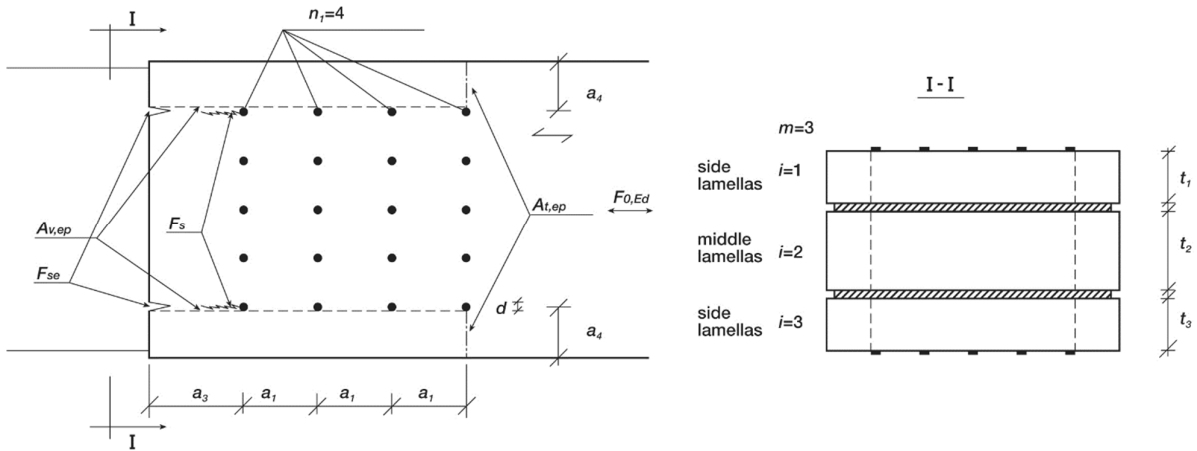

Figure B.2. Definition of symbols for the edge parts of lamellas.

### Screwed connections

The rules given for laterally loaded screws in Eurocode 5 may be applied for Kerto-LVL connections. The effective diameter of  $d_{\text{ef}}$  is used to determine the yield moment capacity and the embedding strength of the screw. The outer thread diameter  $d$  shall be used to determine spacings, edge and end distances and the effective number of screws.

For screws with an effective diameter  $d_{\text{ef}} > 6$  mm, the additions and replacements given in this certificate for laterally loaded bolted connections should be applied.

For screws with an effective diameter  $d_{\text{ef}} \leq 6$  mm, the rules of nailed connections of Eurocode 5 may be applied with the additional rules given in this certificate for laterally loaded nails. However, for screwed edgewise connections the minimum spacings and distances given in column  $\rho_k \leq 420$  kg/m<sup>3</sup> of Table 8.2 in Eurocode 5 may be used.

## ANNEX C: DESIGN OF AXIALLY LOADED DOWEL-TYPE CONNECTIONS

### General

The principles given for the structural design of axially loaded dowel-type connections in the EN 1995-1-1+A1:2008+A2:2014 (Eurocode 5) may be applied for Kerto-LVL with the following additional or substitutive design values and criteria concerning the characteristics of Kerto-S and Kerto-Q.

For axially loaded dowel-type Kerto-LVL connections (see Figure C.1), the value  $\gamma_M = 1,2$  may be used as the partial factor of connection resistance in ultimate limit states for the fundamental combinations unless a specified value has not been given in the relevant National Annex of EN 1995-1-1.

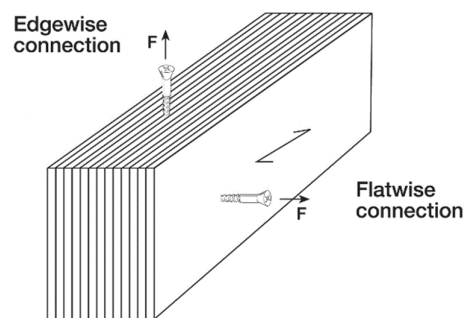

Figure C.1. Definition of axially loaded fasteners.

### Axially loaded nails

The rules of clauses 8.3.2 and 8.3.3 in Eurocode 5 may be applied for flatwise Kerto-LVL connections, where the nails are perpendicular to the plane of the veneers. For edgewise connections, where the pointside of nails are attached to the edge of Kerto-S or Kerto-Q without pre-drilled holes, the following additions should be taken account:

#### Clause 8.3.2(6):

For smooth nails with a penetration of at least  $12d$  in the edge of Kerto-S or Kerto-Q, the characteristic withdrawal strength parameter may be calculated from the following equation

$$f_{ax,k} = 0,32d + 0,8 \quad \text{N/mm}^2 \quad (\text{C.1})$$

In edge connections of Kerto-Q, the minimum nail diameter  $d$  is 3,1 mm for round nails and 2,8 mm for square nails.

**Clause 8.3.2(9):**

The minimum values of nail spacings and distances given in the column  $420 \leq \rho_k \leq 500 \text{ kg/m}^3$  of Table 8.2 for laterally loaded nails apply to axially loaded nails in the edge of Kerto-S and Kerto-Q. However, for nails with a diameter  $d < 5 \text{ mm}$ , the minimum nail spacing parallel to the grain may be taken as  $a_1 = 5d$ .

For Würth's annular ringed hot-dip coated nails 65x2,5 and 90x3,1, the following characteristic withdrawal strength parameters may be used in edge connections of Kerto-S:

- $f_{ax,k} = 3,43 \text{ N/mm}^2$  for Würth 65x2,5
- $f_{ax,k} = 1,97 \text{ N/mm}^2$  for Würth 90x3,1

For Würth's electroplated zinc coated anchor nails 60x4,0 the following characteristic withdrawal strength parameter may be used in edge connections of Kerto-Q:  $f_{ax,k} = 3,13 \text{ N/mm}^2$ .

**Axially loaded screws**

The rules of clauses 8.7.2 and 8.7.3 in Eurocode 5 apply to the flatwise Kerto-S and Kerto-Q connections, where the screws are placed perpendicular to the veneer plane. The edgewise and inclined screwed Kerto-LVL connections should be designed by the following additional rules.

**Axially loaded screws in edgewise connections**

When the screws are parallel to the plane of veneers and perpendicular to the grain direction of face veneers, the rules given for axially loaded screws in EN 1995-1-1:2004+A1:2008+A2:2014 apply to the edge joints of Kerto-S and Kerto-Q with the following modifications of clause 8.7.2:

*Table 8.6 in paragraph (2), following replacements:*

- $a_1 = 10d$  the minimum screw spacing parallel to the grain,
- $a_{1,CG} = 12d$  the minimum end distance and
- $a_{2,CG} = 4d$  the minimum edge distance, that may be reduced up to  $3d$ , when predrilled holes according to Eurocode 5 is used.

*Delete paragraphs (4) and (5) and replace with:*

For connections with selfdrilling screws in accordance with EN 14592 with

- $4,5 \text{ mm} \leq d \leq 8 \text{ mm}$
- $d_1 \leq 0,7d$
- $d_s \leq 0,8d$ , if the smooth shank penetrates to the edge of Kerto.

where

$d$  is the outer thread diameter;

$d_1$  is the inner thread diameter;

$d_s$  is the smooth shank diameter

The characteristic withdrawal capacity should be taken as:

$$F_{ax,Rk} = n^{0,9} f_{ax,k} d \ell_{ef} \quad (C.2)$$

where:

$f_{ax,k} = 10 \text{ N/mm}^2$ ;

$n$  is the number of screws acting together in a connection;

$\ell_{ef}$  is the penetration length of the thread part.

NOTE: Failure modes in the steel or in the timber around the screw are brittle, i.e. with small ultimate deformation and therefore have a limited possibility for stress redistribution.

For the following bore bit screws: Würth Assy plus and Assy VG plus (ETA-11/0190)  $d = 6$  and  $8 \text{ mm}$  and SFS WT-T-6,5 and WT-T-8,2 (ETA-12/0063), the value  $a_{2,CG} = 3d$  may be used as minimum edge distance for the axially load screws both in edgewise and flatwise Kerto-S and Kerto-Q connections. The characteristic withdrawal capacity for edgewise connections of these screws may be calculated by expression (C.2).

## Inclined screwed connections

This design method is given for the calculation of the shear force capacity and joint slip of two or three dimensionally inclined screwed Kerto-S and Kerto-Q connections presented in Figures C.2 and C.3. The screws should be selfdrilling and fully threaded or partially threaded, where the smooth part diameter  $d_s \leq 0,8d$ , when  $d$  is the outer thread diameter.

### Two dimensionally inclined screwed connections

These rules concern the design of a single shear joint according to Figure C.2, where the screw inclination angle  $\alpha = 30^\circ..60^\circ$  both in regard to the connection force and the screwing surface. In two dimensionally inclined connections the screw axis is parallel to the plane defined by the connection force direction and the normal of the joint surface.



Cross screw connection

The cross screw connection is built up of symmetrical screw pairs, in which one screw is under compression and the other under tension.

The characteristic load-carrying capacity of a cross screw connection

$$F_{Rk} = n_p^{0,9} (F_{C,Rk} + F_{T,Rk}) \cos \alpha \tag{C.3}$$

where:

$n_p$  is the number of screw pairs in the joint;

$\alpha$  is the screw angle (see Figure C.2a)

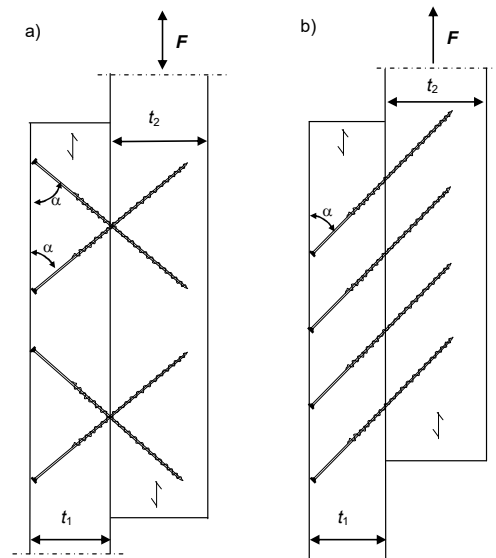

Figure C.2. Inclined screw joint: a) cross screw connection and b) tension screw connection.

The characteristic compression capacity of the screw

$$F_{C,Rk} = \min \begin{cases} f_{ax,1,k} d s_1 \\ f_{ax,2,k} d s_2 \\ 0,8 f_{tens,k} \end{cases} \tag{C.4}$$

and the characteristic withdrawal capacity of the screw

$$F_{T,Rk} = \min \begin{cases} f_{ax,1,k} d s_1 + f_{head,k} d_h^2 \\ f_{ax,2,k} d s_2 \\ f_{tens,k} \end{cases} \tag{C.5}$$

where:

$$f_{ax,i,k} = f_{ax,45,k} \left( \frac{\alpha}{150} + 0,7 \right) \left( \frac{8d}{s_i} \right)^{0,2} \quad (C.6)$$

$d$  is the outer diameter of the thread (screw nominal size);

$s_1$  is the threaded length of the screw in the head side member;

$s_2$  is the threaded length of the screw in the point side member;

$f_{tens,k}$  is the characteristic tensile capacity of the screw determined in accordance with EN 14592; in Table C.3 the tensile capacity of some screws are given;

$f_{ax,45,k}$  is the characteristic withdrawal strength parameter of the screw, which is determined in angle of  $45^\circ$  and penetration length of  $s_2 \geq 8d$  separately for flatwise and for edgewise joints of Kerto-S and Kerto-Q in accordance with EN 14592; in Table C.1 the withdrawal strength parameters of some screws are given;

$\alpha$  is the screw angle ( $30^\circ \leq \alpha \leq 60^\circ$ ), see Figure C.2;

$d_h$  is the head diameter of the screw;

$f_{head,k}$  is the characteristic pull-through parameter of the screw.

The pull through strength of the screw head is determined for Kerto-LVL in accordance with EN 14592 or when the angle between the screw axis and the grain is  $45^\circ$ , it may be calculated for Kerto-S and Kerto-Q products by the following equation:

$$f_{head,45,k} = 57 \left( \frac{d_h}{d} - 1 \right) \quad \text{N/mm}^2 \quad , \text{ when } d_h \leq 2d. \quad (C.7)$$

### Tension screw connection

When the joint consisting of only screws in tension, a contact between the wood members is required. Tension screw connections should not be used in conditions where wood drying could cause a gap of over  $0,2d$ . The gap is determined from the wood shrinkage at a distance of the screw length ( $L \sin \alpha$ ).

The characteristic load-carrying capacity of a tension screw connection

$$F_{Rk} = n^{0,9} F_{T,Rk} (\cos \alpha + \mu \sin \alpha) \quad (C.8)$$

where:

$n$  is the number of screws in the connection;

- $F_{T,Rk}$  is the characteristic withdrawal capacity, using eq. (C.5);  
 $\alpha$  is the screw angle (see Figure C.2b);  
 $\mu$  is the kinetic friction coefficient between the members.

When both surfaces are untreated Kerto-LVL in flatwise (unplanned, unsanded and uncoated), the kinetic friction coefficient in eq. (C.8) may be taken as  $\mu = 0,4$ . For untreated edgewise connections value  $\mu = 0,26$  may be used.

#### Stiffness of two dimensionally inclined screwed connection

The instantaneous slip of an inclined screwed connection

$$u_{inst} = \frac{F}{nK_{ser}} \quad (C.9)$$

where:

- $F$  is the connection force;  
 $n$  is the number of screws (for cross screw joints  $n = 2n_p$ );  
 $K_{ser}$  is the slip modulus for an axially loaded screw according to equation (C.10).

In case of tension joints, a term should be added to equation (C.9), which considers the possible drying shrinkage of the members ( $\delta$ ) as a pre-slip:  $\delta/\tan\alpha$ .

For axially loaded screws the slip modulus

$$K_{ser} = \frac{1}{\frac{1}{K_{1,ser}} + \frac{1}{K_{2,ser}}} \quad (C.10)$$

where:

$$K_{i,ser} = k_{i,ser} d s_i \quad (C.11)$$

The withdrawal stiffness for the threaded part of the screw

$$k_{i,ser} = k_{ser} \left(1 - \frac{|\alpha - 45|}{75}\right) \left(\frac{8d}{s_i}\right)^{0,3} \quad (C.12)$$

where:

- $\alpha$  is the screw angle (see Figure C.2);  
 $s_i$  is the length of the threaded part of the screw in member  $i$ ;

$k_{ser}$  is the mean withdrawal stiffness of the screw, which is determined by testing according to EN 1382 and EN 26891 in an angle of  $45^\circ$  and penetration length of  $s_2 \geq 8d$  separately for flatwise and edgewise joints of Kerto-S and Kerto-Q; in Table C.2 the withdrawal stiffness values of some screws are given.

**Three dimensionally inclined screwed connections**

The following rules concern the design of a single shear joint built up by three dimensionally inclined screw pairs according to Figure C.3 and loaded in the longitudinal direction of Kerto-S or Kerto-Q (parallel to the grain direction of face veneers). In a three dimensionally inclined screwed connection the screwing angle  $\alpha$  is  $30^\circ..60^\circ$  in regard to the thickness direction of Kerto and the angle  $\beta$  between the screw axis and the longitudinal direction Kerto is at maximum  $45^\circ$ . Separate rules are given for three dimensionally inclined screwed connections, where a specific gap between the Kerto members is left in the screwing of the connection.

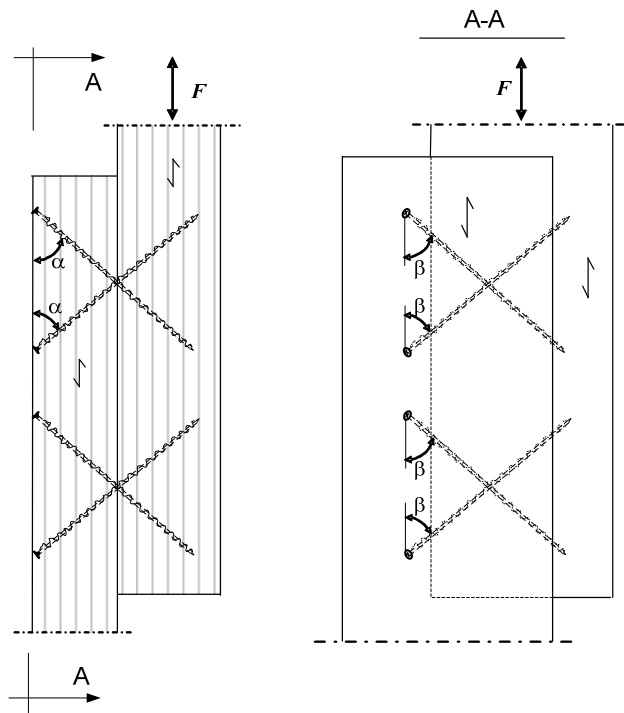

Figure C.3. Three dimensionally inclined screwed connection.

**Connections without joint gap**

When the joint members are compressed together, the characteristic load-carrying capacity of the three dimensionally screwed connection

$$F_{3D,Rk} = F_{2D,Rk} \cos \beta \tag{C.13}$$

where:

- $F_{2D,Rk}$  is the load-carrying capacity of two dimensional cross screwed connection calculated by equation (C.3) with screwing angle  $\alpha$ ;
- $\beta$  is the angle between screw axis and longitudinal direction of Kerto-LVL (see Figure C.3).

#### Connections with joint gap

When a gap at maximum  $2,5d$  wide is left between joint members, the characteristic load-carrying capacity of a three dimensionally screwed connection

$$F_{3D,g,Rk} = \sqrt{nF_{v,Rd} \sin \alpha \cdot F_{2D,g,Rk} \cos \beta} \leq F_{3D,Rk} \quad (C.14)$$

where:

- $n$  is the number of the screws in the connection;
- $F_{v,Rd}$  is the lateral load carrying capacity per screw calculated by expression (8.6) of Eurocode 5 with the application rules given in this certificate;

$$F_{2D,g,Rk} = n_p^{0,9} \cdot 2 \min(F_{C,Rk}; F_{T,Rk}) \cos \alpha \quad (C.15)$$

- $n_p$  is the number of the screw pairs in the connection;
- $F_{C,Rk}$  is the characteristic compression capacity according to the equation (C.4);
- $F_{T,Rk}$  is the characteristic withdrawal capacity according to the equation (C.5).

#### Stiffness of three dimensionally inclined screwed connection

The instantaneous slip of the three dimensionally inclined screwed connection is calculated by equation (C.9) using the following values of slip modulus:

- connections without joint gap

$$K_{3D,ser} = K_{ser} \cos \beta \quad (C.16)$$

- connections with a gap of at maximum  $2,5d$  wide between Kerto members:

$$K_{3D,g,ser} = \frac{1}{\frac{1}{K_{3D,ser}} + \frac{1}{K_{S,ser}}} \quad (C.17)$$

when:

$K_{ser}$  is the slip modulus for an axially loaded screw according to equation (C.10);

$K_{S,ser}$  is the slip modulus of laterally loaded screw according to Eurocode 5 (for Kerto-S and-Q:  $K_{S,ser} = 500d$  N/mm).

### Structural detailing

Different types or sizes of screws may not be combined in the same joint. All the screws are placed with the same inclination angles  $\alpha$  and  $\beta$ . The screws are placed centrally to the connection force.

In flatwise connections, thickness of the Kerto-S member has to be generally at least:

$$t = \max \begin{cases} 5d \\ 12d - 36 \text{ mm} \end{cases} \quad (\text{C.18})$$

where  $d$  is the nominal diameter of the screw. In cases of bore bit Assy VG plus or SFS-WT-T screws, the minimum thickness of Kerto-S member  $t = 4,5d$ .

The minimum thickness of Kerto-Q member is  $3d$  at the head side of screw and at the point side member it is determined by the required penetration length of the screw.

Unless specific values has not been determined for the actual screw by testing, the minimum spacings and end and edge distances should be taken from Table 8.6 of EN 1995-1-1:2004/A1:2008 and in the case of edgewise connection with the following replacements:  $a_1 = 10d$  and  $a_{1,CG} = 12d$ .

In three-member flatwise connection, screws may overlap in the central member provided  $(t_2 - l)$  is greater than  $3d$  (see Figure C.4). For edgewise screws no overlap should be used.

The minimum point side penetration length of the threaded part should be  $6d$ . The screws are screwed deep enough so that the screw heads are in full contact with the member surface. The members should be compressed together so that no gaps are present, except for the three dimensionally inclined screwed connection designed for a specific gap size. If pre-drilling is applied, the lead hole diameter shall not be greater than the inner thread diameter  $d_1$ .

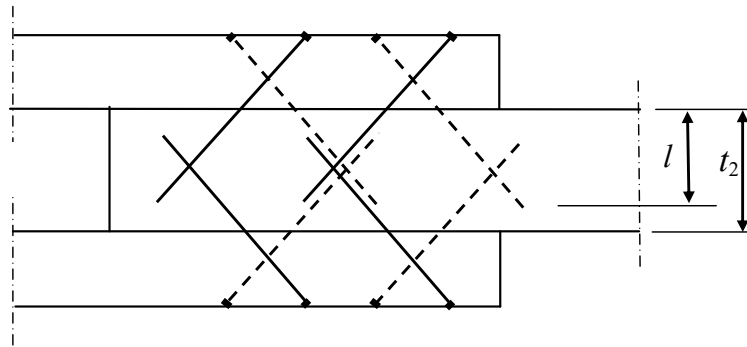

Figure C.4 Overlapping screws.

#### Withdrawal parameters and tensile capacities of some screws

The values of the characteristic withdrawal strength parameter  $f_{ax,45,k}$  and the mean withdrawal stiffness  $k_{ser}$  are presented in Tables C.1 and C.2 for the general screws, ABC Spax-S screws, SFS-WT-T screws and for Würth's AMO III and Assy VG plus screws. For these screws, the values of characteristic tensile capacities presented in Table C.3 may be used.

Here, the term general screw is defined as a selfdrilling screw in accordance with EN 14592 with the inner thread diameter  $d_1 = 0,6...0,7d$  and the outer thread diameter  $d = 5,0...10,0$  mm. The thread advance should be  $0,40...0,55d$  per revolution. The values presented in Tables C.1 and C.2 concern sharp tip general screws (screw tip angle  $15...40^\circ$ ), where the thread may be wavelike, notched or indented to improve the drilling, but at the point, no chisel or star-shaped drill tip is allowed. The head of the general screw may be countersunk or cylinder form. The tensile strength of general screws  $f_{u,k}$  should be at least  $500$  N/mm<sup>2</sup>. For ABC Spax-S screws, the withdrawal strength and stiffness values given for the general screws in Tables C.1 and C.2 may be used.

The Würth's AMO III-screws are fully threaded AW-screwhead screws. The values presented in Tables C.1 and C.2 concern nominal diameters (thread outer diameter)  $d = 7,5$  mm AMO III screws. The screws are manufactured with a countersunk head  $d_h = 12,0$  mm (type 1) or with a cylinder head  $d_h = 12,5$  mm (type 3) or as unheaded  $d_h = 7,5$  mm (type 2, AW25) or  $d_h = 8,0$  mm (type 2, AW30).

The SFS Intec's WT-T-screws are bore bit screws, which have been threaded separately both at head and point side and have a smooth shank at the middle of the screw. The outer thread diameter (nominal diameter) of the SFS-WT-T screws is  $6,5$  or  $8,2$  mm. The head diameter  $d_h$  is  $8,0$  mm for WT-T-6,5 screws and  $10,0$  mm for WT-T-8,2 screws.

The Würth's Assy VG plus screws are fully threaded bore bit screws. The outer thread diameter (nominal diameter) of the Assy VG plus screws is 6,0 or 8,0 mm. These screws are manufactured with different head types. For the cylinder head type, the head diameter  $d_h$  is 8,0 mm for the 6 mm screws and 10,0 mm for the 8 mm screws. The diameter of countersunk head is respectively 12,0 mm for the 6 mm screws and 15,0 mm for the 8 mm screws.

The minimum spacings and end and edge distances of SFS-WT-T and Assy VG plus screws may be taken both for flatwise and edgewise connections from Table 8.6 of EN 1995-1-1:2004/A1:2008 with following reductions:  $a_2 = 4d$  and  $a_{2,CG} = 3d$ .

Table C.1. Characteristic withdrawal strength parameter  $f_{a,45,k}$  (N/mm<sup>2</sup>) for threaded part of general, ABC Spax-S, AMO III, SFS-WT-T and Assy VG Plus screws.

Material and screwing surface		Screw, $d$ (mm)					
		General / Spax-S		AMO III	SFS-WT-T	Assy VG Plus	
		5,0..7,0	8,0..10,0	$d = 7,5$	6,5 or 8,2	$d = 6,0$	$d = 8,0$
Kerto-S, -Q flatwise	0°	14	11	12	15,5	15	14
Kerto-S flatwise <sup>2)</sup>	45°... 90°	14	11,5	12	15,5	15,5	14
Kerto-Q flatwise <sup>2)</sup>	45°... 90°	14	11	12	15,5	17	15
Kerto-S edge/end <sup>3)</sup>	0° / 90°	12	9,5	10,5	13,5	12,5	12
Kerto-Q edge/end <sup>3)</sup>	0° / 90°	13,5	10,5	10,5	13,5	13	13

<sup>1)</sup> direction between connection force and the grain direction of the outer veneers

<sup>2)</sup> these values may be used also for three dimensionally inclined screwed connections, when  $\beta = 45^\circ$

<sup>3)</sup> screws are parallel to the veneers

Table C.2. Mean withdrawal stiffness  $k_{ser}$  (N/mm<sup>3</sup>) for threaded part of general, Spax-S, AMO III, SFS-WT-T and Assy VG Plus screws.

Material and screwing surface		Screw, $d$ (mm)						
		General / Spax-S		AMO III	SFS-WT-T		VG Plus	
		5,0..7,0	8,0..10,0	$d = 7,5$	6,5	8,2	6,0	8,0
Kerto-S flatwise	0°	19	12	17	13	9,5	12	9
Kerto-Q flatwise	0°	21	13	14	13	9,5	10	7,5
Kerto-S flatwise <sup>2)</sup>	45°... 90°	11	9	10	20	18	16	14
Kerto-Q flatwise <sup>2)</sup>	45°... 90°	16	11	13	11	9	22	17
Kerto-S edge/end <sup>3)</sup>	0° / 90°	13	8,5	13	12	9,5	14	11
Kerto-Q edge/end <sup>3)</sup>	0° / 90°	18	12	18	16	13	19	15



- 1) direction between connection force and the grain direction of the outer veneers  
 2) these values may be used also for three dimensionally inclined screwed connections, when  $\beta = 45^\circ$   
 3) screws are parallel to the veneers

*Table C.3. Characteristic tensile capacity  $f_{tens,k}$  for general, ABC Spax-S, AMO III, SFS-WT-T and Assy VG Plus screws made of carbon steel.*

Screw	General screw					ABC Spax-S carbon steel screw					AMO	SFS-WT-T		VG Plus	
$d$ (mm)	5,0	6,0	7,0	8,0	10	5,0	6,0	7,0	8,0	10	7,5	6,5	8,2	6,0	8,0
$f_{tens,k}$ (kN)	3,5	5,1	6,9	9,0	14,1	7,9	11,3	15,4	17,0	28,0	9,0	10,0	19,0	11,3	18,9